

# INSTRUCTION MANUAL FOR



## RUGER® AR-556®

### AUTOLOADING RIFLE



**NOTE:** Information regarding **RUGER® AR-556®** rifles chambered in .223 Wylde is located at the back of this manual.

– Rugged, Reliable Firearms® –



**READ THE INSTRUCTIONS AND  
WARNINGS IN THIS MANUAL CAREFULLY  
BEFORE USING THIS FIREARM**

© 2018 Sturm, Ruger & Co., Inc.

This manual may not be reproduced in whole or in part without the express written permission of Sturm, Ruger & Co., Inc.

**For Service on This Model Please Call:  
(336) 949-5200 (See p. 42)**

THIS INSTRUCTION MANUAL SHOULD ALWAYS ACCOMPANY THIS FIREARM AND BE TRANSFERRED WITH IT UPON CHANGE OF OWNERSHIP, OR WHEN THE FIREARM IS LOANED OR PRESENTED TO ANOTHER PERSON

[www.ruger.com](http://www.ruger.com)

ND 11-18 R7

## State-By-State Warnings

Certain states require by law that their own specified warning notices in larger-than-normal type be conspicuously included by the manufacturer, distributor or retailer with firearms sold in that state. Sturm, Ruger & Co., Inc. sells its products in compliance with applicable laws and regulations. Because our products may be sold in these states, we include the following:

### California:

#### **WARNING**

“Firearms must be handled responsibly and securely stored to prevent access by children and other unauthorized users. California has strict laws pertaining to firearms, and you may be fined or imprisoned if you fail to comply with them. Visit the Web site of the California Attorney General at <https://oag.ca.gov/firearms> for information on firearm laws applicable to you and how you can comply.

Prevent child access by always keeping guns locked away and unloaded when not in use. If you keep a loaded firearm where a child obtains and improperly uses it, you may be fined or sent to prison.”

#### **ADVERTENCIA**

“Las armas de fuego deben manipularse de manera responsable y segura para evitar el acceso de niños y otros usuarios no autorizados. California tiene leyes estrictas relacionadas con armas de fuego, y usted puede ser multado o encarcelado si no las cumple. Visite el sitio web del Procurador General de California en <https://oag.ca.gov/firearms> para obtener información sobre las leyes de armas de fuego que le son aplicables y cómo puede cumplirlas.

A los niños los atraen las armas de fuego y las pueden hacer funcionar. Ellos pueden causarse lesiones graves y la muerte. Evite que los niños tengan acceso a las armas de fuego guardándolas siempre con llave y descargadas cuando no las esté utilizando. Si usted tiene un arma de fuego cargada en un lugar en que un niño tiene acceso a ella y la usa indebidamente, le pueden dar una multa o enviarlo a la cárcel.”

### **Connecticut:**

“UNLAWFUL STORAGE OF A LOADED FIREARM MAY RESULT IN IMPRISONMENT OR FINE.”

### **Florida:**

“IT IS UNLAWFUL, AND PUNISHABLE BY IMPRISONMENT AND FINE, FOR ANY ADULT TO STORE OR LEAVE A FIREARM IN ANY PLACE WITHIN THE REACH OR EASY ACCESS OF A MINOR UNDER 18 YEARS OF AGE OR TO KNOWINGLY SELL OR OTHERWISE TRANSFER OWNERSHIP OR POSSESSION OF A FIREARM TO A MINOR OR A PERSON OF UNSOUND MIND.”

### **Maine:**

“ENDANGERING THE WELFARE OF A CHILD IS A CRIME. IF YOU LEAVE A FIREARM AND AMMUNITION WITHIN EASY ACCESS OF A CHILD, YOU MAY BE SUBJECT TO FINE, IMPRISONMENT OR BOTH. KEEP FIREARMS AND AMMUNITION SEPARATE. KEEP FIREARMS AND AMMUNITION LOCKED UP. USE TRIGGER LOCKS.”

### **Maryland:**

“WARNING: Children can operate firearms which may cause death or serious injury. It is a crime to store or leave a loaded firearm in any location where an individual knew or should have known that an unsupervised minor would gain access to the firearm. Store your firearm responsibly!”

## **Massachusetts:**

“WARNING FROM THE MASSACHUSETTS ATTORNEY GENERAL: This handgun is not equipped with a device that fully blocks use by unauthorized users. More than 200,000 firearms like this one are stolen from their owners every year in the United States. In addition, there are more than a thousand suicides each year by younger children and teenagers who get access to firearms. Hundreds more die from accidental discharge. It is likely that many more children sustain serious wounds, or inflict such wounds accidentally on others. In order to limit the chance of such misuse, it is imperative that you keep this weapon locked in a secure place and take other steps necessary to limit the possibility of theft or accident. Failure to take reasonable preventive steps may result in innocent lives being lost, and in some circumstances may result in your liability for these deaths.”

“IT IS UNLAWFUL TO STORE OR KEEP A FIREARM, RIFLE, SHOTGUN OR MACHINE GUN IN ANY PLACE UNLESS THAT WEAPON IS EQUIPPED WITH A TAMPER-RESISTANT SAFETY DEVICE OR IS STORED OR KEPT IN A SECURELY LOCKED CONTAINER.”

## **New Jersey:**

“IT IS A CRIMINAL OFFENSE TO LEAVE A LOADED FIREARM WITHIN EASY ACCESS OF A MINOR.”

## **New York City:**

“THE USE OF A LOCKING DEVICE OR SAFETY LOCK IS ONLY ONE ASPECT OF RESPONSIBLE FIREARM STORAGE. FOR INCREASED SAFETY, FIREARMS SHOULD BE STORED UNLOADED AND LOCKED IN A LOCATION THAT IS BOTH SEPARATE FROM THEIR AMMUNITION AND INACCESSIBLE TO CHILDREN AND UNAUTHORIZED PERSONS.”

**North Carolina:**

“IT IS UNLAWFUL TO STORE OR LEAVE A FIREARM THAT CAN BE DISCHARGED IN A MANNER THAT A REASONABLE PERSON SHOULD KNOW IS ACCESSIBLE TO A MINOR.”

**Texas:**

“IT IS UNLAWFUL TO STORE, TRANSPORT, OR ABANDON AN UNSECURED FIREARM IN A PLACE WHERE CHILDREN ARE LIKELY TO BE AND CAN OBTAIN ACCESS TO THE FIREARM.”

**Wisconsin:**

“IF YOU LEAVE A LOADED FIREARM WITHIN THE REACH OR EASY ACCESS OF A CHILD YOU MAY BE FINED OR IMPRISONED OR BOTH IF THE CHILD IMPROPERLY DISCHARGES, POSSESSES, OR EXHIBITS THE FIREARM.”

\* \* \* \* \*

Please check with your licensed retailer or state police for additional warnings which may be required by local law or regulation. Such regulations change constantly, and local authorities are in the best position to advise you on such legal matters.

**FIREARMS SAFETY IS YOUR RESPONSIBILITY**  
**SAFETY MUST BE THE FIRST AND CONSTANT**  
**CONSIDERATION OF EVERY PERSON WHO HANDLES**  
**FIREARMS AND AMMUNITION.**

This Instruction Manual is designed to assist you in learning how to properly use and care for your **RUGER® AR-556®** rifles. Please contact us if you have any questions.

Only when you are certain you fully understand the manual and can properly carry out its instructions should you practice loading, unloading, etc. with live ammunition. If you have any doubts about your ability to handle or use a particular type of gun safely, you should seek supervised instruction. Such personalized instruction often is available from local gun retailers, gun clubs or police departments. If none of these sources can help, visit [www.nra.org](http://www.nra.org) or write to the following address:

National Rifle Association  
11250 Waples Mill Road  
Fairfax, VA 22030-7400

The person possessing a gun has a full-time job. You cannot guess; you cannot forget. You must know how to use your firearm safely. **Do not use any firearm without having a complete understanding of its particular characteristics and safe use.** Remember: There is no such thing as a foolproof gun.

# TABLE OF CONTENTS

|   | Page      |
|---|-----------|
| State-By-State Warning .....                                  | 2         |
| Nomenclature .....  | 8         |
| Locking Device Installation Instructions .....                | 9         |
| General Information .....                                     | 11        |
| Operation of Safety .....                                     | 12        |
| The Bolt Catch .....  | 13        |
| Ammunition .....  | 14        |
| Ruger® AR-556® 450 Bushmaster Bolt .....                      | 14        |
| Magazines .....   | 15        |
| To Load and Fire (With Magazine) .....                        | 17        |
| To Load and Fire (Without Magazine) .....                     | 19        |
| To Unload .....   | 20        |
| To Reload the Rifle .....                                     | 21        |
| To Extract and Eject a Chambered Cartridge .....              | 22        |
| To Remove a Bore Obstruction .....                            | 22        |
| To Clear a Malfunction (“Jam”) .....                          | 24        |
| To Minimize Malfunctions (“Jams”) .....                       | 25        |
| Disassembly .....   | 27        |
| Reassembly .....  | 33        |
| Stock Adjustment .....  | 38        |
| Magazine Inspection and Care .....                            | 38        |
| Care and Cleaning .....                                       | 39        |
| Storage .....   | 40        |
| Front Sight Zeroing Procedure .....                           | 40        |
| Rear Sight Instructions .....                                 | 41        |
| Service and Parts Policy .....                                | 42        |
| Shipping Firearms for Repair .....                            | 42        |
| Ordering Parts .....  | 43        |
| Parts List .....  | 44        |
| Exploded Views .....  | 46 - 48   |
| AR-556® Free-Float Handguard Parts List & Exploded View ..... | 49        |
| <b>The Basic Rules of Safe Firearms Handling .....</b>        | <b>50</b> |
| Warranty Information .....                                    | 56        |

“RUGER” is a registered U.S. trademark.



## WARNINGS OF GREAT IMPORTANCE ARE FOUND ON THE FOLLOWING PAGES:

|                  |    |                   |    |
|------------------|----|-------------------|----|
| Locking Devices  | 9  | Unloading         | 20 |
| Alterations      | 11 | Bore Obstructions | 23 |
| Manual Safety    | 12 | Malfunctions      | 26 |
| Ammunition       | 14 | Disassembly       | 27 |
| Lead Exposure    | 15 | Lubrication       | 39 |
| Firing           | 17 | Storage           | 40 |
| Handling         | 18 | Shipping          | 42 |
| Sustained Firing | 19 | Parts Purchasers  | 43 |

**OTHER CAUTIONS AND WARNINGS APPEAR THROUGHOUT THE MANUAL.**

# NOMENCLATURE

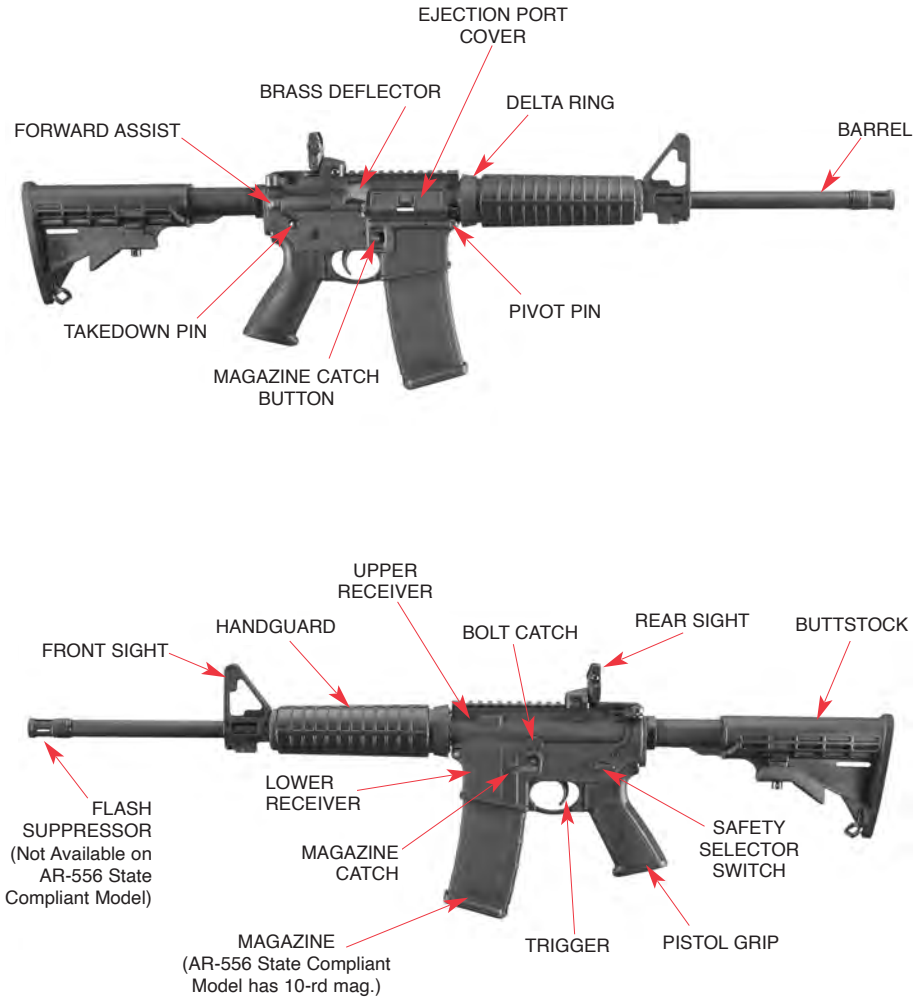

**Figure 1.** In these illustrations the frequently used operating components are identified.



# LOCKING DEVICE INSTALLATION INSTRUCTIONS



## WARNING – USE OF LOCKING DEVICES



**Do not store keys  
in lock.**

- Always keep your firearm pointed in a safe direction, including when you are installing or removing your locking device.
- Always verify that your firearm is completely **unloaded** before installing your locking device.
- Do **not** install locking devices in the trigger guard; always keep your fingers and locking device outside the trigger guard during device installation and removal.
- Store firearms, ammunition and keys separately and securely, away from children and careless adults; do **not** store your firearm with the keys in the locking device.
- Do not attempt to work the action of your firearm with the locking device in place; this may damage your firearm.
- While locking devices are an important aid to security measures, they are not a substitute for safe firearm handling and proper storage. Remember that any mechanical device can be bypassed with enough time, knowledge, determination and equipment.

**LOCKING DEVICES MUST BE USED  
SAFELY AND RESPONSIBLY**

It is important to use the locking device on your Ruger® firearm when the firearm is stored or immediate use is not planned.

### To Install the Factory-Supplied Locking Device:

1. **Keep the muzzle pointed in a safe direction and your fingers outside the trigger guard at all times!**
2. **Remove the magazine from your rifle.**
3. Lock the bolt to the rear by retracting the charging handle fully rearward while depressing the bottom part of the bolt catch, then release the charging handle. (Refer to the “Disassembly” section on page 27.)
4. **Verify that the firearm is completely unloaded and contains no cartridges or cartridge cases!**

5. Insert the cable directly into your rifle as shown in Figure 2.
6. To lock: With the key turned to the farthest clockwise position, insert the loose end of the cable into the lock. Turn the key counterclockwise and remove the key.
7. Once the lock is securely closed, pull firmly on the lock to test the connection and be sure it is locked. **Do not leave or store your firearm with the key in the lock!** Store your locked unloaded firearm and the key in secure, separate locations, away from ammunition, children and unauthorized adults.



Figure 2

*Correct Installation of Lock  
For **RUGER® AR-556®** Rifles*

**FIREARMS ARE DANGEROUS WEAPONS  
READ THE INSTRUCTIONS AND WARNINGS IN THIS  
MANUAL THOROUGHLY AND CAREFULLY BEFORE USING.**

|  |  |
|--|--|
|  <b>WARNING-ALTERATIONS</b> |  |
|                             | This product was designed to function properly in its original condition. Alterations can make it unsafe. Do not alter any part or add or substitute parts or accessories not made by Sturm, Ruger & Co., Inc. |
|  | <b>DO NOT ALTER ANY GUN</b>  |

## **GENERAL INFORMATION AND MECHANICAL CHARACTERISTICS**

The **RUGER® AR-556®** rifle is a gas impingement driven box magazine fed, autoloading rifle. The mechanism utilizes the gas from the firing of the round to drive the bolt carrier rearward and rotate a bolt that locks into the barrel. The **AR-556®** rifle can be field stripped without the use of tools and breaks down into basic subassemblies.



The safety, located above the trigger on the left side of the lower receiver, blocks the trigger and permits the bolt carrier to be cycled with the safety in the on or “SAFE” position. A bolt catch mechanism is provided for convenience in holding the bolt open for loading and inspection. The firing pin is retracted mechanically as the bolt starts to unlock and the rifle will fire only when the bolt is locked.

The **RUGER® AR-556®** free-float handguard model has the same basic operational characteristics as the **AR-556®**. The free-float handguard is designed to accept the Magpul® M-Lok® system.

## OPERATION OF SAFETY

The manual safety mechanism is located above the trigger on the left side of the lower receiver for convenient operation and is on when in its fully horizontal position pointing to the the word “SAFE.” (See Fig. 3.) The safety can be moved to “SAFE” anytime the hammer is cocked. When the safety is on “SAFE,” it blocks the trigger. **The safety should always be placed on “SAFE” before loading or unloading the rifle and should be kept on “SAFE” at all times except when actually firing.**



|  |  |
|--|--|
|   |  |
| <h3>WARNING – MANUAL SAFETY</h3>   |  |
|  <p><b>Safety in “ON” Position</b></p> | <p>Keep the safety on unless actually firing. Always move the safety fully to its intended position and <u>check</u> it. The safety is not “ON” unless it is completely “ON.” Never depend on a safety mechanism or any other mechanical device to justify careless handling or permitting the rifle to point in an unsafe direction. The only “safe” rifle is one in which the bolt is open, the chamber is empty, and there is no magazine in the gun.</p> |
| <b>KNOW HOW TO USE THE SAFETY</b>  |  |

# THE BOLT CATCH

The **AR-556®** rifle is designed so that the bolt remains open after the last shot has been fired, provided there is a magazine in the rifle. When the magazine is empty, the magazine follower actuates the bolt catch, which is designed to retain the bolt and slide in their rearward position.

**WARNING:** The bolt catch is **NOT** a safety device. It should not be used to hold the bolt back when there are cartridges in the magazine. A slight jar to the butt end of the rifle **CAN** cause the bolt catch to disengage and to feed a cartridge into the chamber.

The bolt catch should be relied upon to hold the bolt in its rearward position only when the chamber is empty and an empty magazine is in place. The bolt catch is there for convenience when changing magazines and to hold the bolt in its rearward position when the rifle is unloaded for cleaning or inspection.

## OPERATION OF BOLT CATCH

**To hold the bolt carrier open:** (See Figure 4.)

1. Pull the charging handle all the way to the rear.
2. Depress the bottom part of the bolt catch plunger and allow the bolt carrier to move forward until it stops.
3. Put the safety on "SAFE" (pointing to the word "SAFE").

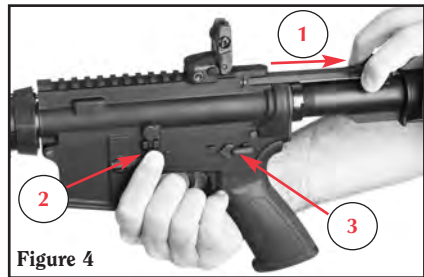

**To release the bolt carrier** (which allows the bolt to move forward) keep selector on "SAFE" and either:

1. Remove the magazine, draw the charging handle to the rear and release. Allow the handle to spring forward freely. Do not "ride" the charging handle or otherwise retard the forward motion.
2. Push the top part of the bolt catch toward the lower receiver and the bolt carrier will release. (See Figure 5.)





**CAUTION:** Bolt carrier is under heavy spring tension and can injure fingers when it slams shut.

# AMMUNITION

The **RUGER® AR-556®** rifle is chambered for many of the most popular cartridges. The particular caliber for each rifle is marked on the barrel. Use cartridges only of the designated caliber that is marked on the barrel.

If you are unable to determine the correct caliber of your **RUGER® AR-556®** rifle, please contact the Customer Service Department at 336-949-5200. See “Ammunition Notice” & “Warning - Ammunition,” below.

## USE ONLY FACTORY AMMUNITION LOADED TO U.S. INDUSTRY STANDARDS

|   |  |                             |
|---|--|-----------------------------|
|  |  | <b>WARNING – AMMUNITION</b> |
|  | Death, serious injury and damage can result from the wrong ammunition, bore obstructions, powder overloads or incorrect cartridge components. <b>Even the strongest gun can be “blown up” as a result of excess pressure. Always wear shooting glasses and hearing protection.</b> |                             |
|  | <b>IMPROPER AMMUNITION DESTROYS GUNS</b>   |                             |

### AMMUNITION (CARTRIDGES) NOTICE

WE SPECIFICALLY DISCLAIM RESPONSIBILITY FOR ANY DAMAGE OR INJURY WHATSOEVER OCCURRING IN CONNECTION WITH, OR AS THE RESULT OF, THE USE IN RUGER FIREARMS OF FAULTY, OR NON-STANDARD, OR “REMANUFACTURED” OR HAND LOADED (RELOADED) AMMUNITION, OR OF CARTRIDGES OTHER THAN THOSE FOR WHICH THE FIREARM WAS ORIGINALLY CHAMBERED.

### RUGER® AR-556® 450 BUSHMASTER BOLT

To accommodate the large case head of the 450 Bushmaster cartridge, the geometry and materials of the bolt and barrel extension have been engineered for rugged, reliable operation. They are NOT mil-spec and should not be used in any other firearm. Keep the bolt carrier group and barrel assembly together.



## WARNING – LEAD EXPOSURE



Discharging firearms in poorly ventilated areas, cleaning firearms, or handling ammunition may result in exposure to lead and other substances known to the State of California to cause birth defects, reproductive harm, and other serious physical injury. Have adequate ventilation at all times. Wash hands thoroughly after exposure.

**SHOOTING OR CLEANING GUNS  
MAY EXPOSE YOU TO LEAD**

## MAGAZINES

**RUGER® AR-556®** rifle magazines are 30-round or less, 5.56mm magazines (marked on the follower). Some **RUGER® AR-556®** models have 5 or 10-round magazines for those states and locales with magazine capacity restrictions. Use only high-quality AR-style magazines which are clean and in good working order. Magazines that have been tested and approved for use with the **RUGER® AR-556®** are available through Ruger Accessories sales Monday through Friday, 7:30 a.m. - 6:00 p.m. at 1-888-220-1173 ET or 24 hours a day, 7 days a week on the web at [www.ShopRuger.com](http://www.ShopRuger.com).

## LOADING THE MAGAZINE

Use only clean, dry ammunition of the proper caliber manufactured to U. S. Industry specifications, in good condition. (See Notice and Warnings in other sections of this manual pertaining to Ammunition).

To load the magazine, align each cartridge with the bullet forward (pointing toward the short end of the magazine) and push downward until the cartridge snaps into place. Place the next round and repeat until the desired number of cartridges are loaded. Do not attempt to load more than the designated number

**DAMAGED, NON-STANDARD OR IMPROPERLY  
ASSEMBLED MAGAZINES SHOULD NOT BE USED.  
THEY CAN CAUSE THE RIFLE TO MALFUNCTION.**

## INSERTING THE MAGAZINE

See Figure 6. The magazine may be inserted with the bolt carrier either in the closed or open position (see “Bolt Catch” section p. 11), although significantly more force will be necessary to insert the magazine with the bolt in the closed position.

1. Hold the magazine as shown and insert it all the way up into the magazine well.
2. Check to be sure that the magazine is securely latched into place.



## REMOVING THE MAGAZINE

To remove the magazine, simply push the magazine catch button toward the side of the lower receiver until the magazine drops out of the magazine well. To minimize the possibility of damage and malfunctions, do not let the magazine drop to the ground (see Figure 7).

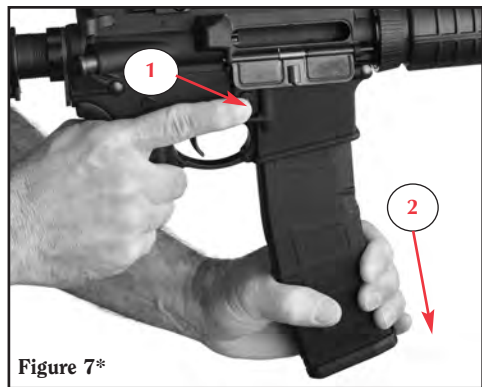

\* **NOTE** – Figures 6 and 7 depict 30-round magazines. Some AR-556® models are equipped with 5 or 10-round magazines for those states and locales with magazine capacity restrictions.



## TO LOAD AND FIRE (WITH MAGAZINE)



Practice this important aspect of gun handling (with an unloaded rifle) until you can perform each of the steps - described below - with skill and confidence. But before you do anything with the rifle, please first read completely through this manual. This procedure begins with an empty rifle with its magazine out.

1. **Be certain the muzzle is pointing in a safe direction. (See Rule 2, p. 50.)**
2. Before inserting a loaded magazine, engage the bolt catch so the bolt carrier is held open. Check the chamber to be certain it is empty. **MOVE THE SAFETY TO THE ON "SAFE" POSITION.** (See Figure 3, p. 12.)
3. Load a magazine with the desired number of cartridges.
4. Insert the loaded magazine into the magazine well, and push the upper pad on the bolt catch towards the side of the lower receiver. A cartridge will be stripped from the magazine and chambered by the motion of the bolt carrier.

**WARNING: If cartridges do not feed smoothly from the magazine into the chamber then do not use the rifle until the problem is corrected.** (See "Warning - Malfunctions," p. 26.)

5. The rifle is now cocked and a cartridge is chambered. Visually check to be certain the safety is in the on or the "SAFE" position, and keep the rifle pointed in a safe direction.

**NOTE:** If the bolt does not completely close, press the forward assist (see Figure 1, p. 8, top photo). This should move the bolt completely forward. If the forward assist does not chamber a round, see the "Clearing Misfires" section of this manual. You may now manually close the ejection port dust cover by raising it and "clicking" it into the closed position, covering the bolt.

|  <b>WARNING – FIRING</b> |   |
|---|---|
|                          | <p>The bolt carrier automatically opens and shuts quickly while firing. Keep face and hands away from it. Hot brass and powder gas is ejected quickly and can burn you. The rifle should be fired from the right shoulder. Always wear shooting glasses and hearing protection.</p> |
| <b>BOLT OPENS FAST – HOT BRASS EJECTED</b>  |   |

- When you are ready to fire the rifle, move the safety to the “FIRE” position.

**WARNING: DO NOT TOUCH THE TRIGGER UNTIL YOU ARE ACTUALLY READY TO FIRE. KEEP THE SAFETY “ON” UNLESS ACTUALLY FIRING.**

- The rifle will fire one shot each time the trigger is pulled until the magazine is empty. The gas produced by the combustion of the powder in the cartridge is used to drive the bolt carrier rearward. This process ejects the fired cartridge case, recocks the gun, and loads a new cartridge from the magazine into the firing chamber.
- Immediately following the firing of a shot, and if a subsequent shot is not to be fired at once, put the safety in the on “SAFE” position while the rifle is still pointing in a safe direction.** The safety should be moved to the “SAFE” position as soon as firing is completed, and it should be on “SAFE” at all times except when the rifle is on target and being fired.
- When the last cartridge in the magazine has been fired, the bolt catch will automatically engage and hold the bolt carrier in the rearward, open position.

|  <b>WARNING – HANDLING</b>               |  |
|---|--|
|  <p>SAFETY IN "OFF" (FIRE) POSITION</p> | <p>If dropped or struck with the safety “off”, the rifle may fire. Keep chamber empty unless actually firing! Keep the safety in the “SAFE” position unless actually firing!</p> |
| <p><b>ANY GUN<br/>MAY FIRE IF<br/>DROPPED</b></p>   |  |



## WARNING – SUSTAINED FIRING



The AR-556® rifle fires from a closed bolt. Sustained firing can create excessive heat in the barrel and can cause “cook-off” of ammunition (heat-firing of the cartridge in the chamber). This “cook-off” can occur a substantial period of time after firing has ceased. Always unload the firearm and unload the chamber immediately after you have finished shooting.

**HOT BARREL CAN  
“COOK-OFF” (FIRE)  
CARTRIDGE IN CHAMBER**

## TO LOAD AND FIRE (WITHOUT MAGAZINE)

The rifle can be used as a single-shot rifle in the absence of a magazine or for safety or training purposes.

1. Be certain the muzzle is pointing in a safe direction. (See Rule 2, p. 50.)
2. Retract the bolt and engage the bolt catch so the bolt carrier is held open. Check the chamber to be certain it is empty. MOVE THE SAFETY TO THE ON “SAFE” POSITION. (See Figure 3, p. 12.)
3. Manually load a cartridge into the chamber.
4. Ensure that your fingers are clear of the chamber and bolt area. Push the top part of the bolt catch toward the lower receiver and the bolt will release.

**CAUTION: Bolt carrier is under heavy spring tension and can injure fingers when it slams shut.**

5. The rifle is now cocked and a cartridge chambered. Visually check to be certain the safety is in the on or the “SAFE” position, and keep the rifle pointed in a safe direction.
6. When you are ready to fire the rifle, move the safety to the “FIRE” position.

**WARNING: DO NOT TOUCH THE TRIGGER UNTIL YOU ARE ACTUALLY READY TO FIRE. KEEP THE SAFETY “ON” UNLESS ACTUALLY FIRING.**

7. After firing, engage the safety. Note that the bolt will not automatically lock open after the cartridge is fired and automatically ejected.



## WARNING – UNLOADING



The rifle can be used as a single loader, it will fire whether or not a magazine is in the gun if a cartridge is chambered. Removing the magazine does not unload the rifle! To unload, first remove the magazine, then pull the charging handle to the rear, eject the chambered cartridge, and visually inspect the chamber. **The safety should always be in the “SAFE” position when loading or unloading the rifle.**

**GUN WILL FIRE WITH  
MAGAZINE OUT**

## TO UNLOAD

**WARNING:** This sequence must be followed exactly! Failure to do so can result in the rifle's chamber becoming unintentionally loaded with a cartridge!

1. Keep the muzzle pointed in a safe direction at all times and keep fingers outside the trigger guard. **Rotate the safety to the “SAFE” position.**
2. Remove the magazine. **REMEMBER** that even though the magazine has been removed, a cartridge remaining in the chamber can still be fired!
3. Pull the charging handle all the way to the rear, extracting and ejecting the cartridge in the chamber.
4. When the bolt carrier is fully retracted, push down on the bottom pad of the bolt catch and then allow the bolt carrier to move forward until it comes to rest against the bolt catch.
5. **Always visually double check the chamber to be certain it is empty.**
6. The only “safe” rifle is one in which the bolt carrier is open and the chamber and magazine are empty, and the muzzle is pointed in a safe direction.

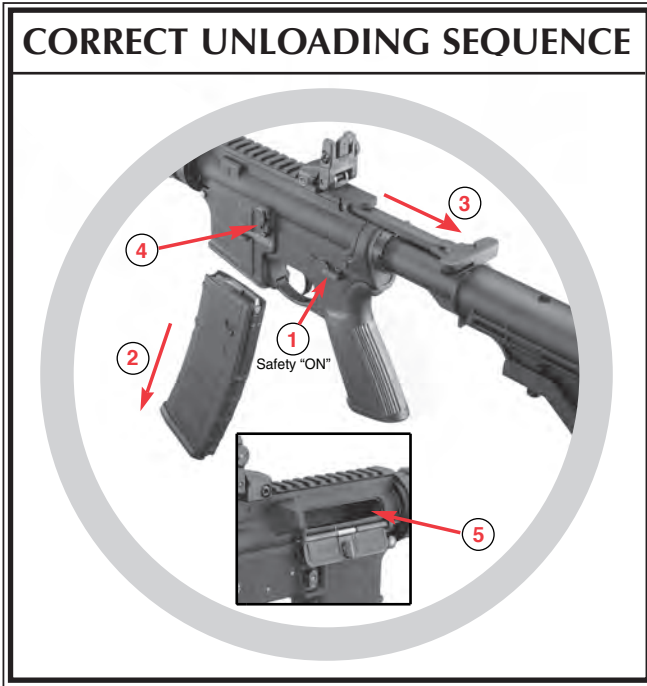

## TO RELOAD THE RIFLE

1. Firing all cartridges in the magazine and the chamber will cause the bolt carrier to automatically lock open. **Keep the rifle pointed in a safe direction.** Put the safety in the "SAFE" position. Removal of the magazine can be accomplished by pressing inward on the magazine catch with the thumb or forefinger. The magazine will fall free of the rifle by its own weight. To avoid the possibility of damage to the magazine, do not let it fall to the ground.
2. Insert a loaded magazine. **WARNING: The bolt catch is held in place by friction between the bolt face and the rear surface of the bolt catch. Therefore, when there is a loaded magazine in place and the rifle is jarred, the bolt can release and chamber a cartridge.**
3. Release and allow the bolt carrier to move forward by pushing in on the top pad of the bolt catch. A cartridge will be chambered when the bolt carrier shuts. **WARNING: The rifle is ready for instant use once the bolt carrier moves forward.** If the rifle is not to be fired immediately, keep the safety on "SAFE." When you are ready to fire immediately, move the selector to the "FIRE" position and resume firing, putting the safety back on "SAFE" whenever you cease firing, even for a moment.

## TO EXTRACT AND EJECT A CHAMBERED CARTRIDGE

When the rifle is fired, the same gas pressure that drives the bullet forward acts through the gas port to push the bolt carrier to the rear. This action causes extraction and ejection of the fired cartridge case. If a cartridge fails to fire, or if the shooter wishes to eject the chambered cartridge manually, follow the procedure "To Unload" step 3, p. 20. When the charging handle is operated there can be a failure to extract the cartridge from the chamber, or a failure to eject the cartridge clear of the rifle. These failures usually are the result of the charging handle not being pulled rearward vigorously. From the foregoing, it is clear that the user must:

1. Always visually check the chamber after opening the slide to eject a chambered cartridge.
2. Thoroughly clean the chamber and the extractor as often as necessary.

If an empty magazine is in the rifle when the charging handle is being retracted to extract a cartridge, the cartridge may drop on top of the magazine or remain held to the breech-face by the extractor. Then, when the bolt carrier goes forward, the cartridge will be chambered again! **REMEMBER -- always remove the magazine before clearing the chamber, and visually check to ensure that no cartridges remain in the gun.**

## TO REMOVE A BORE OBSTRUCTION

Rifles like the **RUGER® AR-556®**, which are chambered for small caliber, high-velocity cartridges, are particularly susceptible to damage from firing when the bore is obstructed. Excess oil, grease or water may form an obstruction which could cause damage and injury. If you suspect that your rifle may have excess oil, grease or other contaminants in the barrel, or if it may have been exposed to humid conditions which could cause condensation, or to rain or snow which might have entered the bore, open the bolt carrier and clean out the barrel. Inspect the bore visually to be sure that it is perfectly clear. (See "Warning - Ammunition," p. 14 and "Care and Cleaning" section p. 39.)

A gun user should recognize that a lodged bullet is a fairly common form of bore obstruction. Therefore, the following information on how a bullet may become lodged in the bore, and how it should be removed, deserves most careful reading and understanding!



## WARNING – BORE OBSTRUCTIONS



Before loading or shooting the AR-556® rifle, be certain the bore is unobstructed. Firing the rifle with any obstruction in the bore may result in severe damage to the rifle and serious injury to the shooter and other persons nearby.

A MISFIRE or unusual report (sound) upon firing is always a signal to cease firing immediately and after waiting for one minute, examine the chamber and bore of the firearm. It is not sufficient to retract the charging handle and examine the chamber. You must remove the magazine, clear the chamber, lock the bolt carrier open and inspect the chamber visually. Then close the bolt. Disengage the take down pin, remove the bolt and carrier (see “Disassembly” p. 28 & 29, steps 3 & 4) and inspect the bore visually, and with a rod if necessary - to be certain it is completely clear of any obstruction. Failure to detect and correctly remove a bore obstruction can result in serious injury to the shooter and bystanders, and damage to the firearm.

**DO NOT “SHOOT OUT”  
A BORE OBSTRUCTION**

1. When firing, a bullet may become lodged in the bore if the cartridge contains no powder, or the powder fails to ignite and only the primer charge ignites, producing insufficient force to propel the bullet out of the bore.
2. A bullet may also become lodged in the bore when extracting a cartridge from the chamber (unloading). If the bullet is not crimped tightly enough in the cartridge case, the bullet may stick in the bore, with only the case being extracted.

Experience indicates that the two conditions described above occur most frequently with reloaded ammunition.

When either of the above described (1 or 2) situations occur, proceed as follows with the rifle pointing in a safe direction:

- a) If the rifle is cocked, move the safety to the “SAFE” position.
- b) Remove the magazine from the rifle.
- c) Retract the charging handle and lock it in the open position by pressing on the bottom pad of the bolt catch in the lower receiver. Retracting the charging handle should remove the cartridge case. Be certain the safety is in the “SAFE” position.
- d) Check the chamber to be certain there is no cartridge case in it – if there is, extract it before proceeding with steps (e) and (f).
- e) After making sure the chamber is clear and the magazine is removed, close the bolt, disengage the takedown pin, remove the bolt and carrier (see “Disassembly” p. 28 & 29, steps 3 & 4) and inspect the bore visually and with a rod as necessary.

- f) If the bore is obstructed, insert a proper size cleaning rod (without a tip or brush) into the bore from the muzzle and dislodge and remove the bullet. If the bullet does not readily dislodge, it may be necessary to lightly tap the handle end of the cleaning rod. If such efforts fail to dislodge the bullet, take the rifle to a gunsmith. **DO NOT ATTEMPT TO REMOVE A LODGED BULLET USING A BLANK CARTRIDGE, OR A CARTRIDGE FROM WHICH THE BULLET HAS BEEN REMOVED, OR BY ANY MEANS OTHER THAN THE USE OF THE PROPER SIZE CLEANING ROD AND REASONABLE FORCE APPLIED TO THE ROD. BE CERTAIN ALL LOOSE POWDER HAS BEEN REMOVED FROM THE BORE AND ACTION BEFORE INTRODUCING THE ROD INTO THE BORE. NEVER TRY TO SHOOT OUT A BORE OBSTRUCTION!** See “Warning - Bore Obstructions,” p. 23.
- g) Reinspect the bore to be certain it is free of unburned powder particles or any other debris. At the same time, clean the magazine, the magazine well and other areas of the mechanism of unburned powder grains.

It is absolutely essential that steps (a) through (g) be followed if there is any suspicion that a bullet has been lodged in the bore because of the situations described in 1 or 2 above. Remember that a bullet can be lodged in the bore of a rifle just where the rifling begins, and a live cartridge can still be chambered and the bolt closed and locked. This can occur because the bullet in the chambered cartridge is pushed back into the cartridge case far enough to give the shooter the impression that the loaded cartridge has chambered normally.

Always check the bore for an obstruction if you experience difficulty in chambering a cartridge, experience a failure to extract, have a misfire or the rifle does not make a normally loud report on firing.

RELOADERS SHOULD USE ONLY CANNELURED BULLETS AND BE SURE TO CRIMP THEM SECURELY IN THE CARTRIDGE CASE. NOTE: Sturm, Ruger & Co., Inc. specifically does not recommend the use of reloaded, hand-loaded or remanufactured cartridges. Please see “Ammunition Notice” p. 14.

## TO CLEAR A MALFUNCTION (“JAM”)

If you experience a malfunction, study the situation to determine the nature of the malfunction and how best to clear it. Any autoloading firearm may occasionally malfunction. If it does:

1. Be certain the muzzle is pointed in a safe direction and the safety is in the on (“SAFE”) position.
2. When attempting to free a jammed cartridge, do not use any type of tool that is likely to act as a “firing pin” and discharge the cartridge should the tool impact the primer. Never use a cartridge as a “tool.”
3. After clearing a jam, inspect the gun mechanism to determine if dirt or debris might be the cause of the problem. Excess lubricant or grease can cause cartridges to feed sluggishly. An accumulation of grease, dirt or powder grains in the magazine can contribute to cartridge feeding problems.



4. After clearing a jam, inspect all cartridges that have been removed from the gun. Safely dispose of any cartridges which are dented, nicked or have bullets that are loose or improperly positioned in the cartridge case.
5. If it appears that the gun and magazine are not at fault, and that the jam was caused by the type of cartridge being used, then try another type or brand of cartridge.
6. If the above procedures do not result in a smooth and reliable feeding firearm, don't use the gun until it feeds cartridges smoothly and reliably. The rifle should be returned directly to our Mayodan, NC Customer Service Department for repair. See the "Service and Parts" section p. 40, for packing and shipping information.

Another precaution: Form the habit of examining fired cartridge cases from time to time. If fired cases have bulged heads or show splits on any part of the case, stop using that ammunition. If the problem persists with different types of ammunition, return the rifle to the factory for inspection. (See page 42.)

7. If a cartridge is caught between the bolt carrier and receiver, put the safety on "SAFE," remove the magazine, retract the bolt carrier using the charging handle, and lock it in the open position using the bolt catch. Then remove the jammed case.
8. If a fired case is in the chamber, use a cleaning rod to knock it out.
9. If an unfired cartridge is stuck in the chamber, keep the muzzle pointed in a safe direction with the safety in the "SAFE" position. Close the bolt, disengage the takedown pin, remove the bolt and carrier (see "Disassembly" p. 28 & 29, steps 3 & 4), and remove the unfired cartridge from the breech-end rather than trying to dislodge it with a cleaning rod inserted from the muzzle. Use a piece of 3/16" brass rod which has one end shaped like a screwdriver tip. Insert the tip in the extractor groove of the cartridge, use the face of the ejection port as a fulcrum and carefully pry out the cartridge. **Be careful not to strike the primer area of the live cartridge!** Vigorously brush-clean the chamber with solvent after clearing any jam involving the chamber.

## TO MINIMIZE MALFUNCTIONS ("JAMS")



Autoloading firearms of all makes and types occasionally malfunction when a cartridge fails to feed from the magazine to the chamber, or when a cartridge (or fired case) fails to properly extract and eject.

To minimize the possibility of such occurrences, the gun user should:

1. Use ammunition of the correct caliber and type which is loaded to Industry Specifications. Avoid reloads, remanufactured cartridges, and cartridges that are dirty, corroded or deformed. (See "Warning - Ammunition," p. 14.)
2. Clean and lubricate the gun in accordance with the instructions in this manual.

3. If the mechanism shows signs of not functioning correctly, or if a part is damaged or broken -- don't use the gun. Have it inspected and repaired. (See "Warning - Malfunctions," below.)
4. Use only high-quality AR-style magazines and carefully load the magazine. Do not exceed the stated magazine capacity. (See "Loading the Magazine," p. 15.)
5. Do not 'ride' the charging handle when chambering a cartridge from the magazine. The bolt carrier should be permitted to snap forward under the full force of the buffer spring. If a cartridge does not fully chamber, use the forward assist no more than twice to force the bolt carrier closed. If the cartridge is still not chambered completely, the round should be cleared as a jam (see p. 24 and "Warning - Bore Obstructions," p. 23.)
6. To minimize the probability of an unfired cartridge being jammed should it 'fall back' onto the magazine, remove the magazine before retracting the bolt carrier. When extracting an unfired cartridge, tip the right side of the rifle towards the ground so that gravity will assist the cartridge to fall clear of the ejection port. Always retract the charging handle briskly whenever extracting a live cartridge. Take care to see that a cartridge is not forcibly ejected against a surface where the primer might be set off.

Alterations to the rifle or use of non-Ruger accessories may cause malfunctions. See "Warning - Alterations," on page 11. If the above procedures do not result in a smooth and reliable feeding firearm, don't use the gun. The rifle can be returned directly to our Mayodan, North Carolina Customer Service Department for repair. See the "Service and Parts Policy" section, page 42, of this manual for packing and shipping information.

|  |  |
|--|--|
|  <h2 style="margin: 0;">WARNING – MALFUNCTIONS</h2> |  |
|    | <p>A cartridge can be "discharged" before it is chambered if its primer receives a sharp blow. If a cartridge hangs up, jams, or binds when being chambered or when being fed from the magazine into the chamber, <b>do not attempt to force it into the chamber by pushing or striking the bolt carrier</b>. The forward assist may be depressed up to two times, after which time if the cartridge is still not chambered completely, the round should be cleared as a jam (see pg. 24). Any jam or feeding problem is a signal to immediately stop using the gun until it can be determined what is wrong. Most failures of a cartridge to feed or to chamber are caused by a damaged magazine, improper gun handling or defective ammunition. <b>Whatever the cause, cartridge jams can result in the potentially very dangerous situation of a cartridge discharging before it is chambered. If this occurs, the cartridge case will rupture and its fragments will fly out of the gun with sufficient force to cause injury. Always wear shooting glasses and hearing protection! Keep face away from chamber!</b></p> |
|   | <p><b>STRIKING RIM OR PRIMER<br/>CAN BURST CARTRIDGE</b></p>   |



## WARNING – DISASSEMBLY

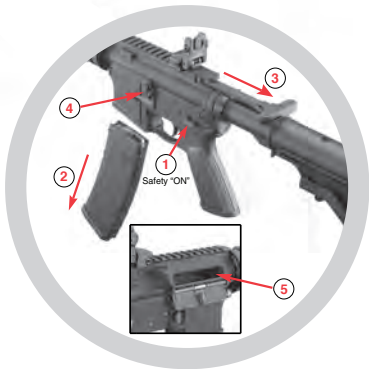

Always unload a firearm before cleaning, lubrication, disassembly or assembly.

**UNLOAD BEFORE  
CLEANING**

## DISASSEMBLY

**Be Sure Rifle Is Unloaded!**

An on-line video demonstrating the disassembly and reassembly of the AR-556® rifle can be viewed by going to [Ruger.com/TechTips](http://Ruger.com/TechTips).

Although the **AR-556®** rifle can be disassembled, reassembled and cleaned in almost any surrounding, it is preferable to carry out these procedures on a workbench or table which has a covered top. A piece of shallow nap rug or an old blanket is an ideal covering. Such a covering keeps the rifle from slipping and being scratched.

### 1. Removing the magazine. (See Figure 8.)

- a. Point the rifle in a safe direction, safety in the “SAFE” position.
- b. Hold magazine in left hand.
- c. With right index finger press inward on the magazine catch button.
- d. Remove magazine and set aside.
- e. Pull the charging handle all the way to the rear.
- f. Depress the bottom part of the bolt catch plunger and allow the bolt carrier to move forward until it stops.
- g. Look in the ejection port window at the chamber to make sure there are no live or spent cases in the chamber.

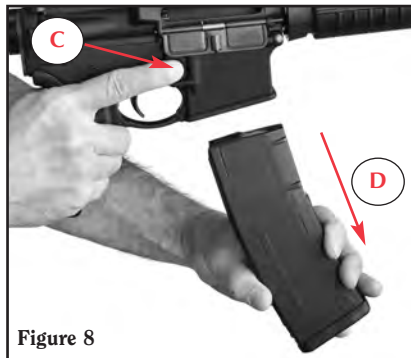

Figure 8

## 2. Release bolt into battery position. (See Figure 9.)

- a. After clearing the chamber and holding the pistol grip in right hand, switch the selector switch to the “SAFE” position.
- b. Press the upper thumb pad of the bolt catch to release the bolt carrier assembly into battery position.



## 3. Disengage takedown pin for field strip. (See Figures 10 & 11.)

- a. On the left-hand side of the lower receiver, push the rear takedown pin to the right. (If the pin is hard to remove use a punch and gently tap with a hammer. The pin will become easier to remove over time.)

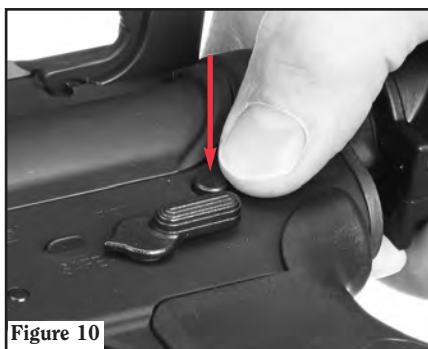

- b. From the right side of the rifle, pull the pin outward until the detent stops any additional travel. (It is best if you hold the upper and lower receivers together until you are ready to open the rifle.) **CAUTION: The upper receiver will move forward once the pin is disengaged and could pinch your fingers if you are holding the magazine well.**



#### 4. Removing bolt carrier assembly and charging handle.

(See Figures 12, 13, 14, & 15.)

- a. Tip the upper receiver forward on the front pivot pin to access the carrier assembly and charging handle.

- b. Unlock the charging handle by holding the handle with the index and middle fingers and pull the handle away from the rifle while compressing the charging handle latch.

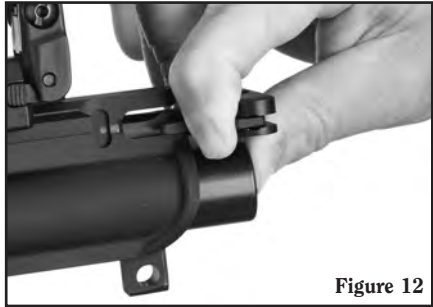

Figure 12

- c. Pull the charging handle about halfway out and stop. The carrier assembly will follow the charging handle.



Figure 13

- d. Grasp the backside of the carrier assembly and remove it from upper receiver and set aside.



Figure 14

- e. Grasp the charging handle and pull it out until the handle stops, slide the handle down and out of the keyhole to remove.



Figure 15

**5. Bolt carrier disassembly.**  
(See Figures 16 - 23.)

- a. Once the bolt carrier is removed from the upper receiver, remove the firing pin retaining pin.



- b. Move the bolt into the locked position.



- c. Remove the firing pin from the bolt carrier.

- d. Turn the bolt cam pin clockwise a quarter turn and lift it out of the bolt carrier.



- e. Remove the bolt from the bolt carrier.

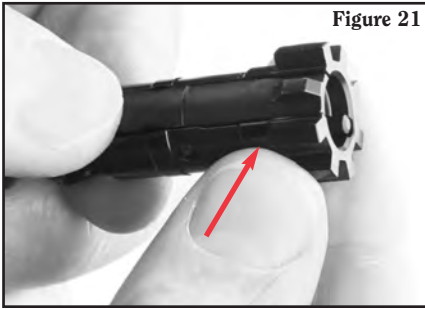

- f. Press the rear of the extractor and check for resistance. If no resistance is present, the extractor must be removed, and the parts must be cleaned.
- g. Use a small punch and remove the extractor pin.
- h. Remove the extractor



## 6. Buffer and Spring Field Stripping. (See Figures 24 & 25.)

- a. Push the buffer towards the rear of the buffer tube.
- b. Press the buffer retainer to let the buffer out.
- c. Remove the buffer and spring.

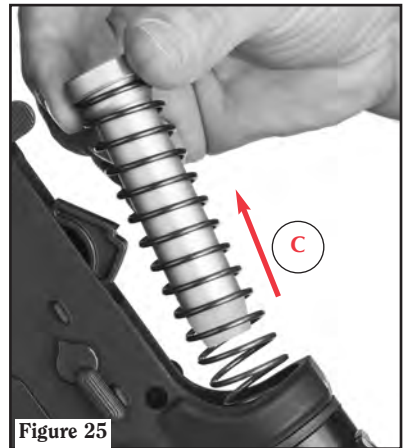

**WARNING:** Do not attempt to stretch or otherwise modify the buffer spring. Functional issues can result from modifications to the buffer spring.

**WARNING:** Do not replace either the buffer or the buffer spring with anything but genuine Ruger® AR-556® parts. Use of other buffers or buffer springs can result in functional issues and reduced endurance life.

**7. Handguard removal.**  
(See Figures 26 - 28.)

- a. Stand the rifle on its buttstock and turn the delta ring clockwise to loosen.
- b. Pull the handguard free.
- c. Repeat this procedure to remove the other handguard.



**8. Removing the upper receiver from the lower receiver.**  
(See Figures 29 & 30.)

- a. With the takedown pin already disengaged, remove the upper receiver from the lower receiver by pushing the pivot pin on the left side of the lower receiver to the right. (If the pin is hard to remove, use a punch and gently tap with a hammer. The pin will become easier to remove over time.)





- b. Reach to the right-hand side of the lower receiver and pull the pivot pin to the right until the detent stops any additional travel. (It is best to hold the upper and lower receivers together until you are ready to remove the upper receiver.)



- c. Lift the upper receiver off the lower receiver to do any additional cleaning.

## REASSEMBLY

**Again Be Sure the Rifle and Magazine are Completely Unloaded!**

### 1. Bolt carrier assembly:

- a. Make sure the grooves in the gas rings are not aligned (see Figure 31). **WARNING:** The splits in the gas rings need to be offset in order for the AR-556® to function properly. If the splits in the gas rings align, they will allow hot gases to flow by the gas rings, and keep the firearm from functioning properly.

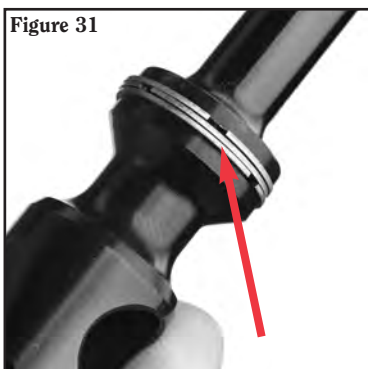

- b. Make sure the extractor spring and extractor buffer spring are in place in the extractor (See Figure 32).



- c. Place the extractor in the slot (Figure 33) and insert the

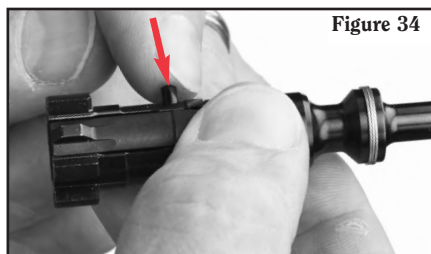

- d. Insert the bolt into the bolt carrier (Figure 35).
- e. Insert the cam pin and rotate a quarter turn counterclockwise (Figure 36).
- f. Insert the firing pin (Figure 37).



Figure 35

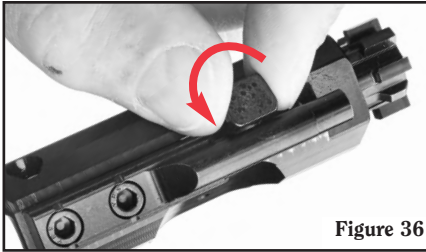

Figure 36

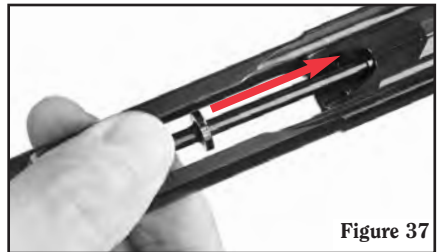

Figure 37

- g. Insert the firing pin retaining pin (Figure 38).

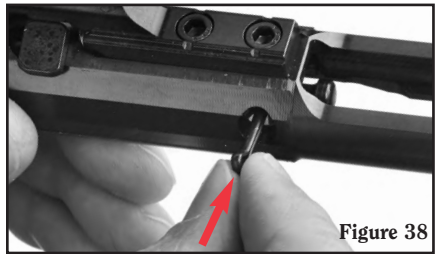

Figure 38

## 2. Buffer and spring assembly:

- a. Insert the spring and buffer into the buffer tube (Figure 39).
- b. Press the buffer retainer and push the buffer toward the rear of the buffer tube (Figure 40).
- c. Release the buffer retainer.

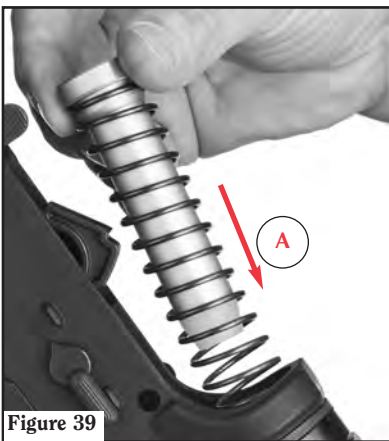

Figure 39

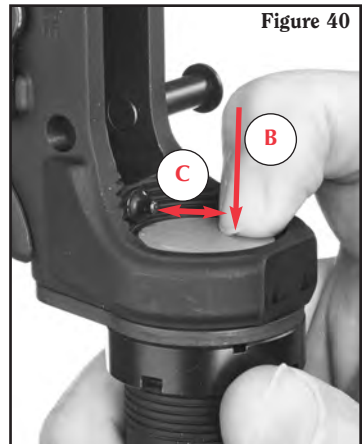
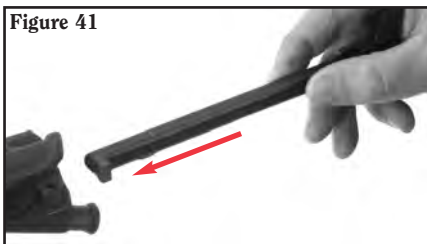

Figure 40

### 3. Reassemble the charging handle and bolt carrier into the upper receiver:

- a. Turn the upper receiver upside down so that the top of the rifle is pointing toward the ground. Install the charging handle with the pick-up lug pointing toward you. (See Figure 41.)



- b. Slip the charging handle guides into the cut out in the upper receiver and leave the charging handle sticking out of the rear of the upper receiver. (See Figure 42.)



- c. Turn the bolt carrier upside down and, making sure the bolt is fully forward, lay the bolt carrier on the charging handle and push both the bolt carrier and the charging handle forward until the charging handle lock engages the upper receiver. (See Figure 43.) Care should be taken not to turn the upper receiver so that the bolt carrier can slide out the back of the upper receiver while the charging handle is unlocked.

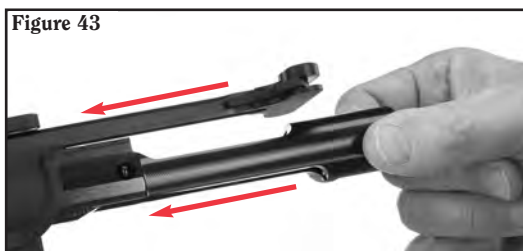

- d. The bolt carrier will not fall out of the upper receiver as long as the charging handle is locked onto the upper receiver. (See Figure 44.)

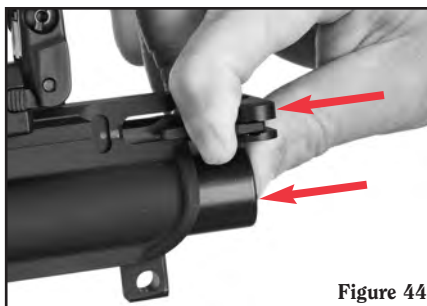

Figure 44

#### 4. Assemble the upper receiver to the lower receiver:

- a. Make sure the hammer is cocked (see Figure 45), place the selector on “SAFE,” and make sure both the takedown pin and pivot pin are pushed completely to the right side of the lower receiver. Make sure the bolt carrier is all the way forward in the upper receiver. Put the upper receiver onto the lower receiver and slide the upper receiver all the way rearward against the threaded section of the buttstock.



Push the pivot pin into the receiver until the detent locks in the hole in the pivot pin. Push the takedown pin into the receiver until the detent locks in the hole in the takedown pin. (See Figure 46.)



## 5. Handguard assembly:

- a. Stand the rifle on the buttstock.
- b. Slide the handguard into place (Figure 47).
- c. Repeat this procedure to install the other handguard (Figure 48).



- d. Tighten the Delta Ring by turning it counterclockwise with your thumb and index finger (two-finger tight). (See Figure 49.)

**CAUTION:** Do not over tighten the Delta Ring. Use two fingers only to tighten.



## STOCK ADJUSTMENT

(Does Not Apply to State Compliant Models)

The **AR-556**<sup>®</sup> rifle comes with a 6-position adjustable stock. The stock on the state compliant models are fixed and are not adjustable. There are locking holes on the underside of the extension tube and there is a spring-loaded pin inside the buttstock. To adjust the stock, squeeze the rear part of the lever on the underside of the stock against the stock, and slide the entire stock assembly in toward the lower receiver, or away from the lower receiver. Release the lever and move the stock slightly in or out until the pin snaps into one of the holes on the extension tube. Try the fit, and if necessary, readjust the stock. (See Figure 50.)

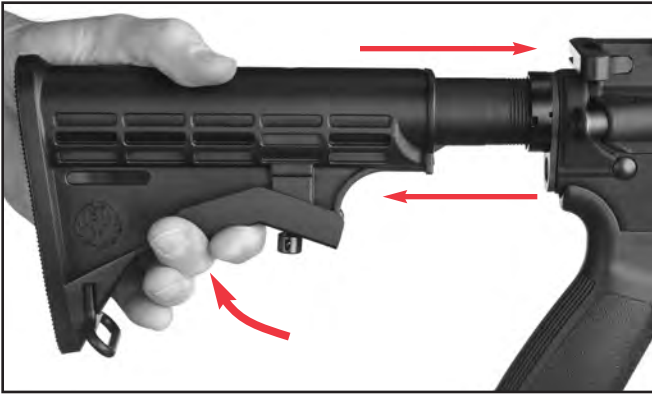

## MAGAZINE INSPECTION AND CARE

Check the magazine frequently. The follower must move freely and have adequate spring tension so that each cartridge is quickly raised to the feeding position.

To test the spring tension, load one cartridge into the magazine and then firmly press against the cartridge case. Remove your finger quickly. The cartridge should instantly and fully move into the feeding position. If it does not, the magazine should be cleaned. **If cleaning does not restore proper spring tension, do not use the magazine.** (NOTE: After testing, remove the test cartridge.)

When cleaning is necessary, use a solvent that will not rust the metal components.

# CARE AND CLEANING



**BEFORE CLEANING, BE CERTAIN THE RIFLE  
AND ITS MAGAZINE CONTAIN NO CARTRIDGES.**

After each shooting session, at regular intervals, or whenever the rifle has been exposed to sand, dust, extreme humidity, condensation, immersion in water or other adverse conditions; disassemble, clean and oil it. Proper periodic maintenance is essential to the reliable functioning of any firearm.

An on-line video demonstrating the proper cleaning procedure of the AR-556® rifle can be viewed by going to **Ruger.com/TechTips**.

To clean the rifle, proceed as follows:

1. Disassemble (field-strip) the rifle to the extent described on pages 27 - 33.  
The handguard and gas block should not be removed for cleaning or maintenance. **Do not disassemble the rifle any further than as described on pages 27 - 33.**
2. Clean the bore with dry patches and examine. Bore fouling can contribute to reduced accuracy, and grease accumulation in the chamber can interfere with proper feeding of the cartridges from the magazine. Using a cleaning rod, run a properly sized, solvent-wetted patch through the bore several times. Then attach a solvent-wetted brush to a cleaning rod and run it back and forth the full length of the bore as many times as necessary to remove grease and dirt from the gas block bore.
3. Using powder solvent on a clean patch or bore brush, remove powder residue from all components of the mechanism. After cleaning, run a dry patch through the bore, then follow with a patch that is very lightly oiled. Wipe all surfaces clean with a cloth, then wipe all surfaces with a patch or cloth that has been very lightly oiled.
4. NOTE: Only a light application of oil is needed to provide adequate lubrication of moving parts and to prevent rust. Excess accumulation of oil tends to attract particles of dust and dirt and may congeal in cold weather which can interfere with the safe and reliable function of the rifle.

|  |   |
|--|---|
|  <b>WARNING – LUBRICATION</b> |   |
|                               | Firing a rifle with oil, grease or any other material even partially obstructing the bore may result in damage to the rifle and serious injury to the shooter and those nearby. Do not spray or apply lubricants directly on ammunition. If the powder of a cartridge is affected by the lubricant, it may not be ignited, but the primer firing may push the bullet into the bore where it may be lodged. Firing a subsequent bullet into the obstructed bore may damage the rifle and cause serious injury or death to the shooter and those nearby. Use lubricants properly. You are responsible for the proper care and maintenance of your firearms. |
| <b>IMPROPER LUBRICATION<br/>DESTROYS GUNS</b>  |   |

# STORAGE

## GUNS SHOULD NOT BE STORED LOADED!

**USE THE LOCKING DEVICE SUPPLIED WITH THE RIFLE FOR STORAGE.**

(See Page 9)

**Do not** store the rifle in a leather case or scabbard. Leather attracts moisture, even though it may appear to be dry.



## WARNING – STORAGE



- Never place or store any firearm in such a manner that it may be dislodged. Firearms should always be stored securely and unloaded, away from children and careless adults.
- Use the locking device supplied with the rifle for storage. The use of a locking device or safety lock is only one aspect of responsible firearms storage.
- For increased safety, firearms should be stored unloaded in a location that is both separate from their ammunition and inaccessible to children and any other unauthorized person.

**STORE SECURELY & UNLOADED**

## FRONT SIGHT ZEROING PROCEDURE

1. Fire a group and measure from the point of aim to the point of impact.
2. Adjust the front sight for elevation only. Adjustments can be made with an AR-15 front sight tool, AK74/47 tool or needle nose pliers.
3. Confirm zero with a group of aimed shots.

### ADJUSTMENT

1. To move the bullet impact up – turn the sight blade to the right/clockwise.
2. To move the bullet impact down – turn the sight blade to the left/counterclockwise.

Figure 51



| Value per 1/4 turn / 90° of adjustment | 100Y  | 200Y  | 300Y  |
|--|-------|-------|-------|
| 1.75 MOA                               | 1.75" | 3.50" | 5.25" |



## REAR SIGHT INSTRUCTIONS

1. Remove the magazine and ensure the chamber is empty.
2. Unscrew the clamp assembly and place the sight so as to allow the clamp screw to rest in the rear most rail cross-slot of the flat-top receiver. Sight should be orientated to fold to the rear (see Figure 52).
3. Apply one drop of thread locking compound on the exposed threads. Replace the clamp and tighten while pushing the sight forward against the cross slot (see Figure 53).

Figure 52



### OPERATION

1. To raise the sight, depress the button located on the left side of the base and the sight will pop-up into position.
2. The sight will automatically fold down as pressure is applied. (See Figure 53.)

### ZEROING PROCEDURES

1. Fire a group and measure from the point of aim to the point of impact.
2. Adjust the rear sight for windage only. (see Figure 54).
3. Elevation adjustment is made off of the front sight post.
4. Sight apertures are on the same plane and can be used without a change of impact.
5. Confirm zero with a group of aimed shots and adjust as necessary.

Figure 53



### ADJUSTMENT (See Figure 54.)

1. To move the bullet impact right – turn adjustment wheel to the right/clockwise.
2. To move the bullet impact left – turn adjustment wheel to the left/counterclockwise.

Figure 54

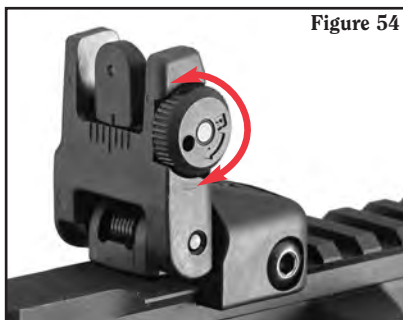

| Value for one click of adjustment | 100Y  | 200Y  | 300Y   |
|-----------------------------------|-------|-------|--------|
| .625 MOA                          | .625" | 1.25" | 1.875" |

## SERVICE AND PARTS POLICY

If you have any question with regard to the performance of your **RUGER® AR-556®** rifle please write or call (336-949-5200) our Customer Service Department in Mayodan, NC, fully describing all circumstances and conditions involved. If you should return your rifle to the factory for repair, or order parts for it, please comply with the following suggestions for prompt service:



**WARNING: BEFORE SHIPPING ANY FIREARM, BE ABSOLUTELY CERTAIN THAT THE FIREARM AND ITS MAGAZINE ARE UNLOADED. DO NOT SHIP CARTRIDGES WITH A FIREARM.**

## SHIPPING FIREARMS FOR REPAIR

**RUGER® AR-556®** rifles returned to the factory for repair should be sent to: Sturm, Ruger & Company, Inc., Customer Service Department, 271 Cardwell Rd., Mayodan, NC 27027. The complete rifle should be shipped. **NOTE: You must obtain a Repair Authorization Number before returning your firearm.** An authorization number can be obtained by contacting Customer Service online at [www.ruger.com](http://www.ruger.com) or calling the Customer Service Dept. at 336-949-5200. Guns should be sent prepaid. We will not accept collect shipments.

The Federal Gun Control Act, as well as the laws of most states and localities, do not prohibit an individual (who is not otherwise barred from purchasing or possessing a firearm) from shipping a firearm directly to the manufacturer for repair. However, before you ship your rifle to us, be certain that your state or locality does not have a law or regulation which will prohibit you from receiving the rifle from us after it has been repaired. If such receiving is prohibited, then please have a federally licensed firearms dealer ship the gun to us. If your rifle is sent to us by a dealer, it will be returned to that dealer after being repaired.

**DO NOT SEND GUN BOXES OR LITERATURE THAT YOU CONSIDER TO BE COLLECTOR'S ITEMS – THESE ARE INVARIABLY DAMAGED OR DESTROYED IN SHIPMENT.** Please do not include rifle case, sling, telescopic sights or custom accessories with a firearm being shipped to the factory for service. Rifles and shotguns may be shipped via U.S. Mail. Always insure your shipment.

Enclose a letter which includes your name, address, telephone number, serial number, model of the firearm, and your repair authorization number. Describe in detail the trouble you have experienced with your firearm, or the work you wish to have done. Merely stating that the firearm “needs repair” is inadequate information.

All work performed is subject to a minimum labor charge and charges for shipping and handling. Most models can be reblued, but custom gunsmithing service or nonstandard alterations are **NOT AVAILABLE** from Ruger Customer Service Departments. Please contact the Customer Service Department for pricing information.



## WARNING – PARTS PURCHASERS



- It is the purchaser's responsibility to be absolutely certain that any parts ordered from the factory are correctly fitted and installed.
- Firearms are complicated mechanisms and **IMPROPER FITTING OF PARTS MAY RESULT IN A DANGEROUS MALFUNCTION, DAMAGE TO THE FIREARM, AND SERIOUS INJURY TO THE SHOOTER AND OTHER PERSONS.**
- The purchaser and installer of parts must accept full responsibility for the correct adjustment and functioning of the firearm after such installation.

**PARTS MUST FIT CORRECTLY**

## ORDERING PARTS

Please contact the Mayodan, NC Customer Service Department for parts availability and current prices. All parts orders for the **RUGER® AR-556®** rifle should be sent to: Sturm, Ruger & Co., Inc., Customer Service Department, 271 Cardwell Rd., Mayodan, NC 27027, 336-949-5200. We cannot comply with open account or C.O.D. requests. Payment in full via credit card (Visa or MasterCard only), money order or certified bank check (no personal checks or cash, please) is required before any service will be performed. Please provide your credit card number, your name as it appears on the credit card, the expiration date, and the 3-digit security code. All parts orders are subject to a minimum charge and charges for shipping and handling. Order parts by **Part Name and specify the model and entire serial number** of the firearm for which the parts are being ordered. There is a minimum labor charge plus a shipping and handling charge if the parts are factory fitted. All factory fitted parts are fit on an exchange basis only. We will not return the replaced parts. Please contact the Customer Service Department for pricing information.

Barrels, and a number of other component parts must be fitted at the factory. Company policy is to proof-test and/or function fire all barrels after fitting to the receivers in which they are to be used. This procedure ensures maximum protection to our customers. The special proof-test ammunition used in this testing is sold only to bonafide firearms manufacturers and is not available to gun shops, gunsmiths or individuals.

Because the receiver of the **RUGER® AR-556®** is a serial numbered component, it is defined as a "firearm" by Federal law and is not sold as a separate component.

\*Parts designated by an asterisk must be factory fitted. These parts are fitted on an exchange basis only. We will not return the replaced parts. We will not return any part that is broken, malfunctioning, badly worn or has been modified. See "Warning – Parts Purchasers," above.



**WARNING: A gun containing broken, malfunctioning or badly worn parts should not be fired.**

# RUGER® AR-556®

## PARTS LIST

Design, prices and specifications subject to change without notice.

**SPECIFY MODEL, CALIBER, AND SERIAL NO. WHEN ORDERING**

(See Exploded Views on Pages 46, 47 & 48)

| <b>Key No.</b> | <b>Part Name</b>   |
|----------------|--|
| 1              | Charging Handle Assembly   |
| 2              | Forward Assist Retainer Pin  |
| 3              | Rear Sight   |
| 4              | Upper Receiver   |
| 5              | Forward Assist Assembly  |
| 6              | Forward Assist Spring  |
| 7              | Ejection Port Cover  |
| 8              | Ejection Port Cover Spring   |
| 9              | Ejection Port Cover Rod  |
| 10             | Ejection Port Cover Retaining Clip   |
| 11             | Barrel Nut, 2 piece  |
| 12             | Handguard  |
| 13             | Delta Ring   |
| 14             | Gas Tube Assembly  |
| * 15           | Barrel Assembly  |
| 16             | Handguard Cap  |
| 17             | Sight Post   |
| 18             | Front Sight Detent   |
| 19             | Front Sight Spring   |
| * 20           | Gas Block  |
| 21             | Flash Suppressor Washer  |
| 22             | Gas Block Taper Pin  |
| 23             | Gas Block Roll Pin   |
| 24             | Flash Suppressor – Not Available<br>on State Compliant Model                 |
| 25             | Butt Stock Assembly – State Compliant<br>Model Has Non-Adjustable Butt Stock |
| 26             | Buffer Spring  |
| 27             | Receiver Extension Nut   |
| 28             | Buffer   |
| 29             | Receiver Endplate  |
| 30             | Buffer Retainer Spring   |
| 31             | Buffer Retainer Plunger  |
| 32             | Disconnecter Spring  |
| * 33           | Disconnecter   |
| * 34           | Hammer Assembly  |

\*PARTS SO MARKED MUST BE FACTORY FITTED

| <b>Key No.</b> | <b>Part Name</b>          |
|----------------|---------------------------|
| 35             | Trigger/Hammer Pin        |
| 36             | Hammer Spring             |
| * 37           | Trigger                   |
| 38             | Trigger Spring            |
| 39             | Bolt Catch                |
| 40             | Bolt Catch Roll Pin       |
| * 41           | Selector Switch           |
| 42             | Bolt Catch Plunger        |
| 43             | Bolt Catch Plunger Spring |
| 44             | Magazine Catch Assembly   |
| * 45           | Lower Receiver            |
| 46             | Takedown Detent           |
| 47             | Takedown Detent Spring    |
| 48             | Selector Detent           |
| 49             | Selector Detent Spring    |
| 50             | Takedown Pin              |
| 51             | Pistol Grip               |
| 52             | Grip Screw Washer         |
| 53             | Pistol Grip Screw         |
| 54             | Trigger Guard Roll Pin    |
| 55             | Trigger Guard             |
| 56             | Magazine Catch Button     |
| 57             | Magazine Catch Spring     |
| 58             | Pivot Pin                 |
| 59             | Firing Pin                |
| 60             | Bolt Carrier Assembly     |
| 61             | Cotter Pin                |
| 62             | Bolt Cam Pin              |
| 63             | Gas Ring                  |
| * 64           | Bolt                      |
| 65             | Extractor Pin             |
| 66             | Ejector Pin               |
| 67             | Ejector Spring            |
| 68             | Ejector                   |
| 69             | Extractor Buffer Spring   |
| 70             | Extractor Spring          |
| 71             | Extractor O-Ring          |
| 72             | Extractor                 |

\* PARTS SO MARKED MUST BE FACTORY FITTED

# RUGER® AR-556®

## UPPER RECEIVER ASSEMBLY

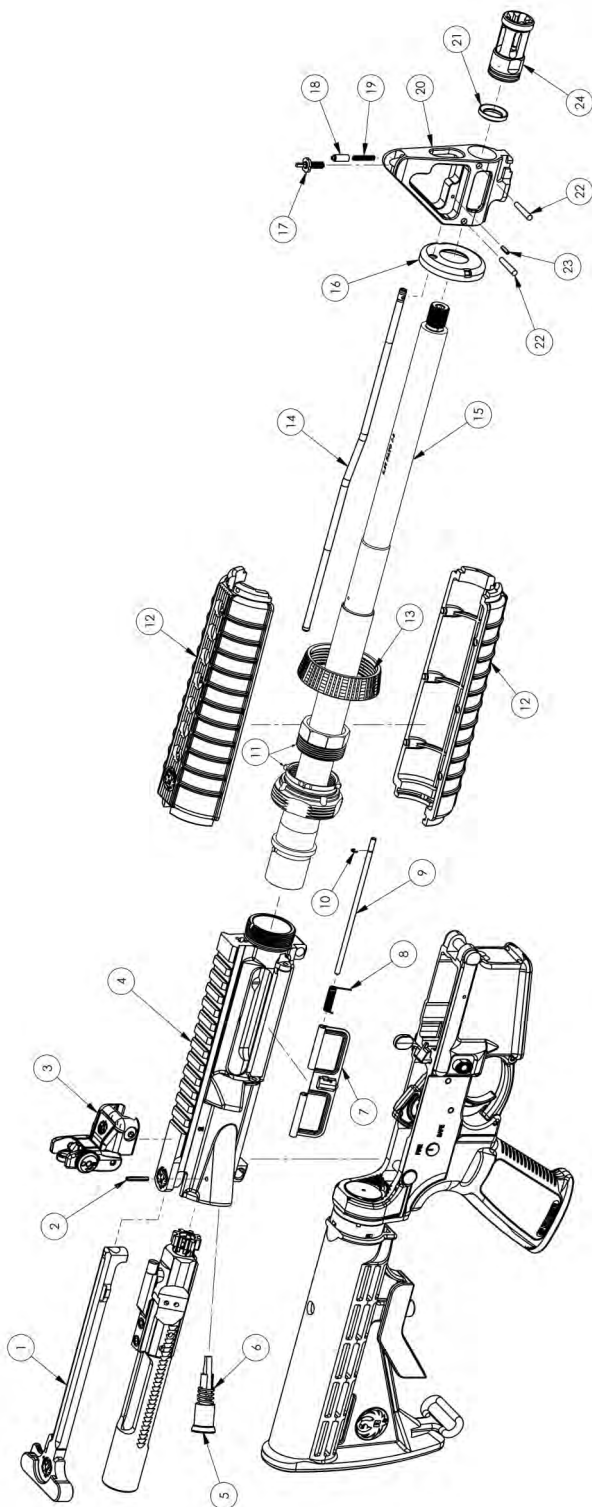

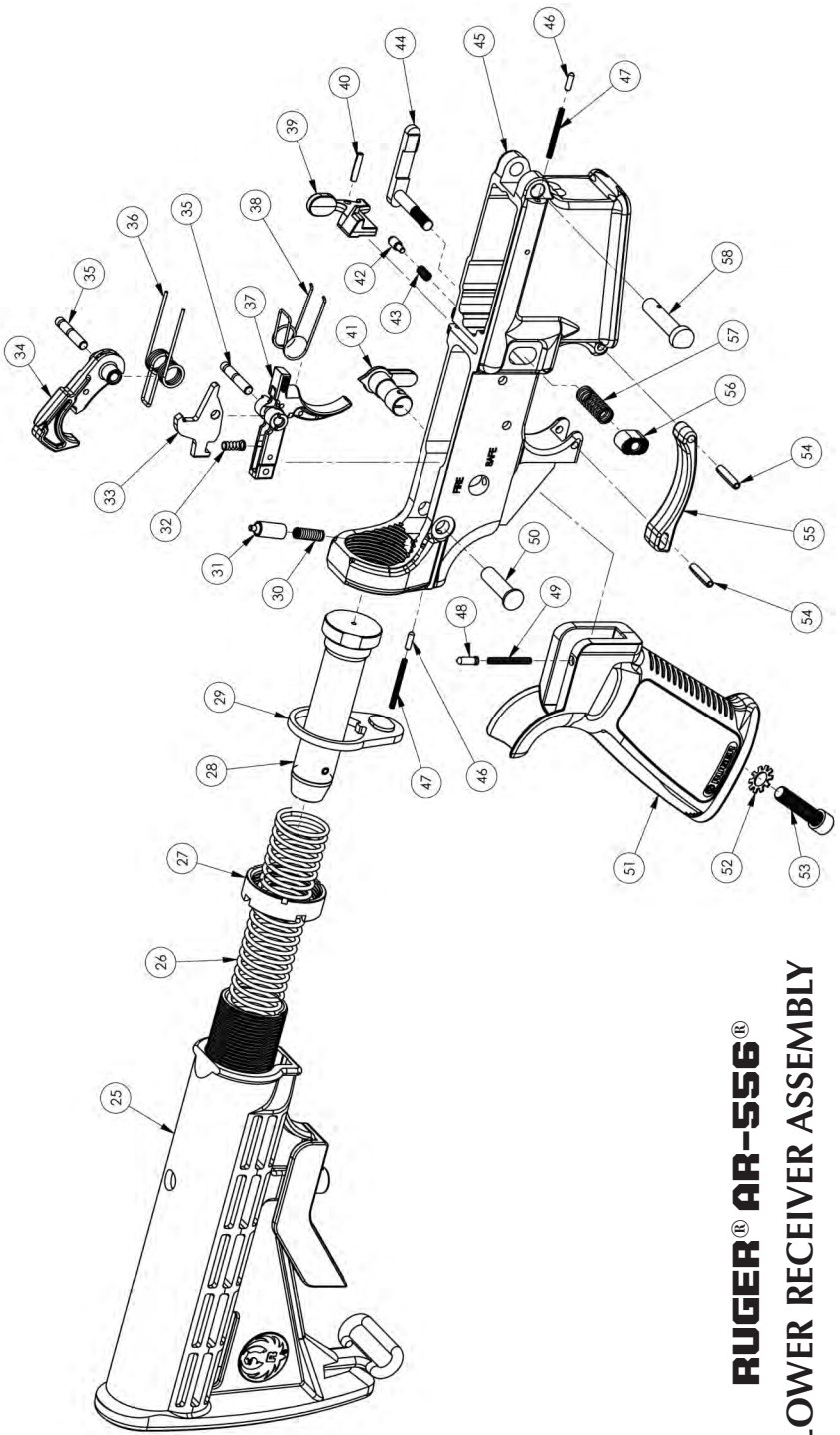

**RUGER® AR-556®**  
**LOWER RECEIVER ASSEMBLY**

# RUGER® AR-556® BOLT CARRIER ASSEMBLY

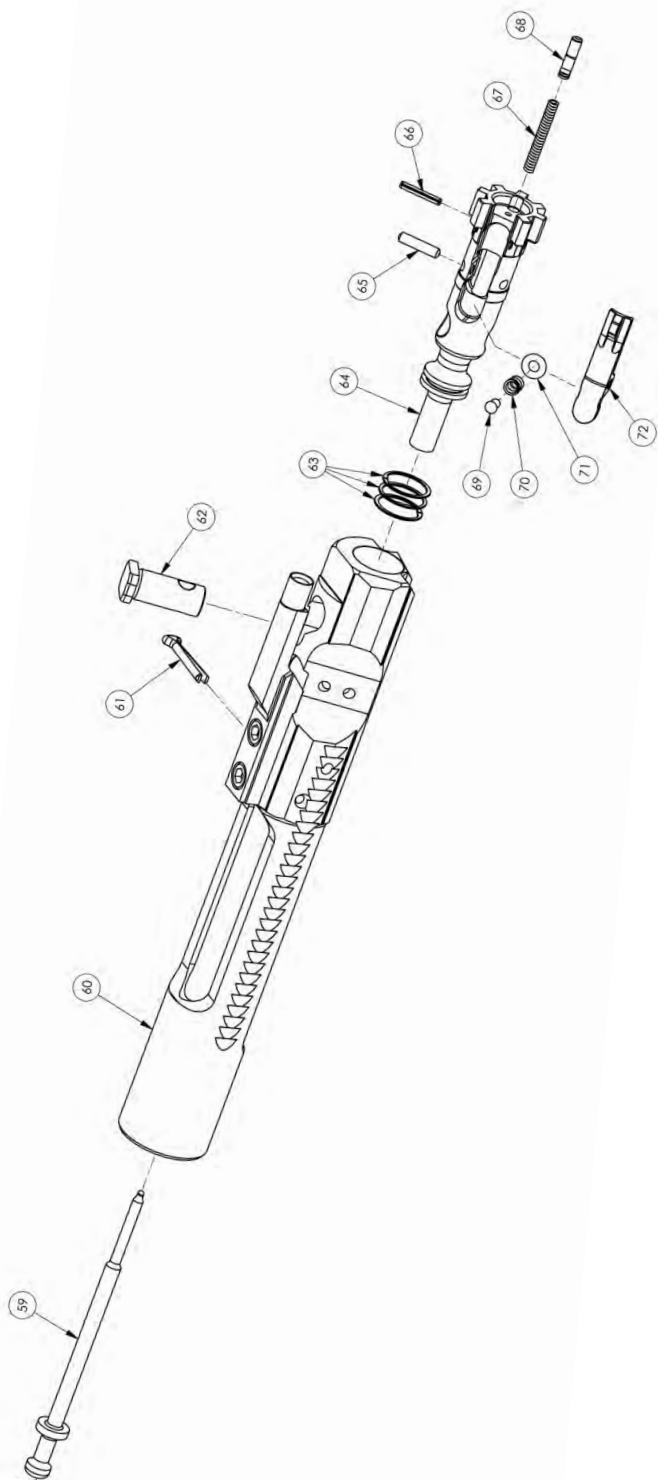



# RUGER® AR-556®

## Free-Float Handguard Models

See pages 44 - 48 for all other parts lists and exploded view drawings.

The free-float handguard is designed to accept the Magpul® M-Lok® system.

### Key No. Part Name

|    |                          |
|----|--------------------------|
| 1  | Upper Receiver           |
| 2  | Handguard                |
| 3  | Handguard Screw, 2 Req'd |
| 4  | Gas Tube Assembly        |
| *  | Barrel Assembly          |
| 6  | Barrel Nut               |
| 7  | Gas Block                |
| 8  | Gas Block Roll Pin       |
| 9  | Gas Block Set Screw      |
| 10 | Muzzle Brake             |

\* PARTS SO MARKED MUST BE FACTORY FIT

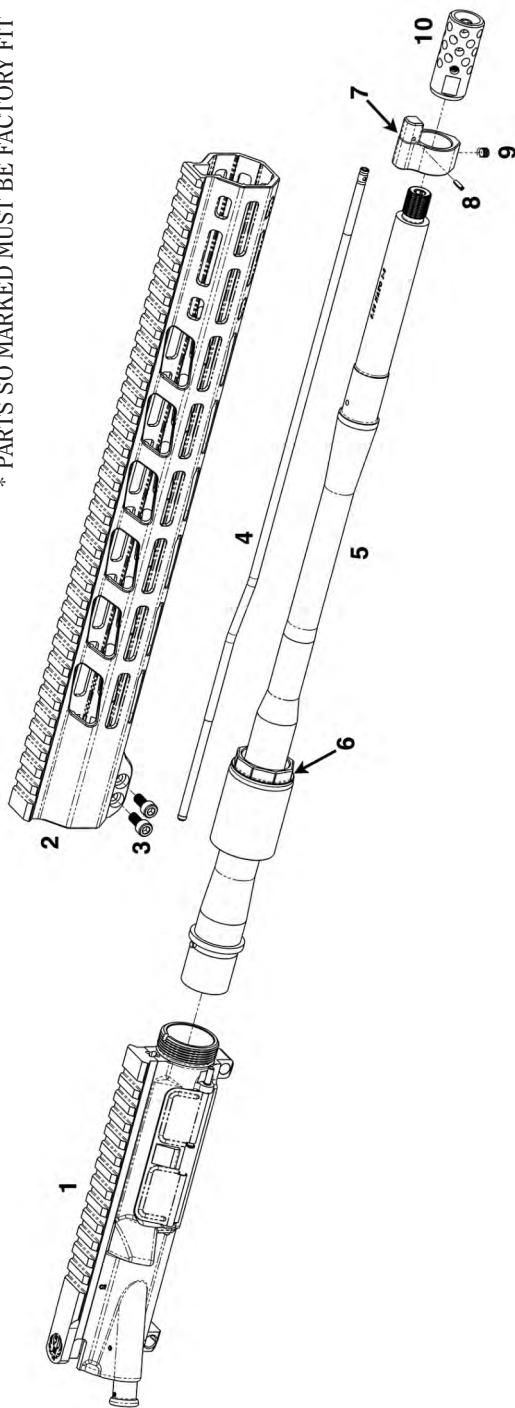

# THE BASIC RULES OF SAFE FIREARMS HANDLING

We believe that Americans have a right to purchase and use firearms for lawful purposes. The private ownership of firearms in America is traditional, but that ownership imposes the responsibility on the gun owner to use his firearms in a way which will ensure his own safety and that of others. When firearms are used in a safe and responsible manner, they are a great source of pleasure and satisfaction, and represent a fundamental part of our personal liberty.

Firearms do not cause accidents! Firearms accidents are almost always found to have been the result of carelessness or ignorance on the part of the shooter of the basic rules of safe gun handling.

The following rules must be observed by gun users at all times. Safe gun handling is not just desirable, it is absolutely essential to your safety, the safety of others, and the continuation of gun ownership and sport shooting as we know it today.

## 1. LEARN THE MECHANICAL AND HANDLING CHARACTERISTICS OF THE FIREARM YOU ARE USING.

Not all firearms are the same. The method of carrying and handling firearms

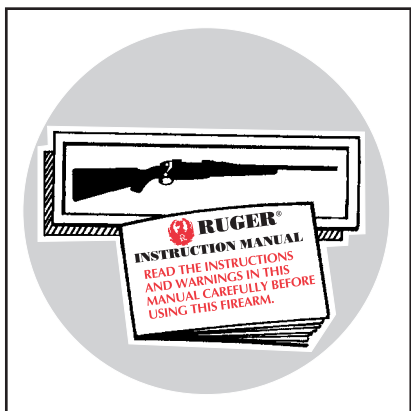

varies in accordance with the mechanical provisions for avoiding accidental discharge and the various proper procedures for loading and unloading. No person should handle any firearm without first having thoroughly familiarized himself with the particular type of firearm he is using, and with safe gun handling in general.

## 2. ALWAYS KEEP THE MUZZLE POINTED IN A SAFE DIRECTION.



Be sure the bullet stop behind your target, even when dry-firing. Never let the muzzle of a firearm point at any part of your body or at another person. This is particularly important when loading or unloading a firearm. In the event of an accidental discharge, no injury can occur as long as the muzzle is pointing in a safe direction. A safe direction means a direction that will not permit a discharged bullet to strike a person, or to strike an object from which the bullet may ricochet.

A safe direction must take into account the fact that a bullet may penetrate a wall, ceiling, floor, window, etc., and strike a person or damage property. Make it a habit to know exactly where the muzzle of your gun is pointing whenever you handle it, and be sure that you are always in control of the direction in which the muzzle is pointing, even if you fall or stumble. Keep your finger off the trigger until you are ready to shoot.

### 3. FIREARMS SHOULD BE UNLOADED WHEN NOT IN USE.

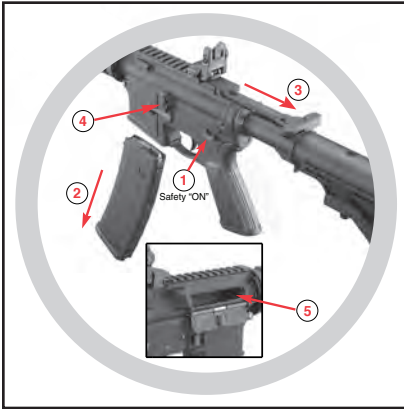

Firearms should be loaded only when you are in the field or on the target range or shooting area, ready to shoot. Firearms and ammunition should be securely locked in safes, racks or cabinets, or by using the locking device supplied with the firearm, when not in use. Ammunition should safely be stored separate from firearms. Store your firearms out of sight of visitors and children. It is the gun owner's responsibility to be certain that children and

persons unfamiliar with firearms cannot gain access to firearms, ammunition, or components.

### 4. BE SURE THE BARREL IS CLEAR OF OBSTRUCTIONS BEFORE SHOOTING.

Even a bit of mud, snow or excess lubricating oil or grease in the bore may cause the barrel to bulge, or even burst on firing, and can cause serious injury to the shooter and bystanders. Be sure that you are using ammunition of the proper caliber and loading for the gun you are using. If the report or recoil on firing seems weak, or doesn't seem quite right, CEASE FIRING IMMEDIATELY, unload your firearm, and check to be sure that no obstruction has become lodged in the barrel. Never try to shoot out an obstruction!





## 5. BE SURE OF YOUR TARGET BEFORE YOU SHOOT.

Don't shoot unless you know exactly where your bullet is going to strike. Be sure of the bullet stop behind your target, even when dry-firing with an unloaded gun. If you are in the field hunting, do not fire at a movement or noise. Take the time to be absolutely certain of your target before you pull the trigger.

## 6. WEAR SHOOTING GLASSES AND HEARING PROTECTION WHEN YOU SHOOT.

All shooters should wear protective shooting glasses and adequate hearing protection when shooting. Exposure to shooting noise can damage hearing, and wearing adequate eye protection when shooting is essential.



## 7. NEVER CLIMB A TREE OR FENCE WITH A LOADED FIREARM.

Put the firearm down carefully before climbing a fence, and unload it before climbing or descending a tree or jumping over a ditch or other obstruction. Never pull or push a loaded firearm toward yourself or another person. When in doubt, or whenever you are about to do anything awkward, unload your gun!

## 8. DON'T SHOOT AT A HARD SURFACE OR AT WATER.

Bullets can glance off many surfaces like rocks or the surface of water and travel in unpredictable directions with considerable velocity.



## 9. NEVER TRANSPORT A LOADED FIREARM.

Firearms should always be unloaded before being placed in a vehicle. A suitable carrying case or scabbard should be used to carry an unloaded firearm to and from the shooting area.

## 10. AVOID ALCOHOLIC BEVERAGES WHEN SHOOTING.

Don't drink until the day's shooting is over. Handling firearms while under the influence of alcohol in any form, or medications that could affect your judgement or coordination, constitutes a criminal disregard for the safety of others.



## A BRIEF ACCOUNT OF AN EXTRAORDINARY ACHIEVEMENT: RUGER® FIREARMS

Sturm, Ruger & Company, Inc., had its beginning in a small machine shop occupying a rented frame building in Southport, Connecticut. In January, 1949, with an initial investment of only \$50,000 and an idea, William B. Ruger and Alexander M. Sturm started production of a .22 caliber autoloading pistol—a design which was so successful that it became the cornerstone upon which one of the most comprehensive lines of sporting firearms ever made in America was established. After Alex Sturm's death in 1951, William B. Ruger continued to direct the Company until his death in 2002. William B. Ruger, Jr. continued to provide guidance, which helped make this Company a sound and successful enterprise, until his retirement in 2006. The Company has continued to prosper, under new management and guidance from our Board, with new products and fresh perspectives.

Ruger, in this relatively short time, has established itself as a leading small arms design organization, developing a unique and broad line of fine quality sporting, military and police firearms to become one of the world's most famous producers of revolvers, pistols, rifles and shotguns. Since 1949, Ruger craftsmen have built many millions of firearms.

During its five decades of growth and progress under the leadership of William B. Ruger, the Company developed a business philosophy and implemented policies which represent a constructive influence in the life of modern America. From the beginning, Ruger played a positive role in conservation efforts and has supported the interests of shooters through such groups as the National Rifle Association, National Shooting Sports Foundation, and many regional sportsmen's organizations.

The Company has always endeavored to market its firearms for constructive and recreational purposes, to emphasize the traditional and responsible aspects of shooting, to render meaningful public services, and to encourage shooters in constructive, responsible, and safe participation in the shooting sports. Its motto, "Arms Makers For Responsible Citizens®," exemplifies this Company philosophy.

Today, Ruger® is particularly mindful of those elements which have contributed to the creation of its success, and extends heartfelt thanks to its many loyal employees and customers.

The firearms catalog, and instruction manuals for all Ruger® firearms, can be downloaded from our website at:

**[www.ruger.com](http://www.ruger.com)**

# NOTES

## WHY NO WARRANTY CARD HAS BEEN PACKED WITH THIS NEW RUGER® FIREARM

The Magnuson-Moss Act (Public Law 93-637) does not require any seller or manufacturer of a consumer product to give a written warranty. It does provide that if a written warranty is given, it must be designated as "limited" or as "full" and sets minimum standards for a "full" warranty. Sturm, Ruger & Company, Inc. has elected not to provide any written warranty, either "limited" or "full", rather than to attempt to comply with the provisions of the Magnuson-Moss Act and the regulations issued thereunder. There are certain implied warranties under state law with respect to sales of consumer goods. As the extent and interpretation of these implied warranties varies from state to state, you should refer to your state statutes. Sturm, Ruger & Company wishes to assure its customers of its continued interest in providing service to owners of Ruger® firearms.



**STURM, RUGER & COMPANY, INC.**  
271 Cardwell Road  
Mayodan, North Carolina 27027 U.S.A.  
[www.ruger.com](http://www.ruger.com)

**Arms Makers For Responsible Citizens®**

A COPY OF THE INSTRUCTION MANUAL FOR ANY RUGER®  
FIREARM IS AVAILABLE FROM THE FACTORY FREE ON REQUEST, OR IT MAY BE  
DOWNLOADED FROM OUR WEBSITE AT [WWW.RUGER.COM](http://WWW.RUGER.COM).  
THESE INSTRUCTION MANUALS CONTAIN IMPORTANT  
WARNINGS WHICH MUST BE UNDERSTOOD  
BEFORE USING THESE FIREARMS.

**The Following are Sturm, Ruger & Co., Inc. Trademarks:** "BX-Trigger," "Bisley," Eagle Hard "R" logo holding gun, "Elite 452," "Gold Label," "I'm a Ruger American," "LC6," "LCR-357," "LC380CA," "Mark II," "Mark III," "Match Champion," "Model 96," "P345," "P345D," "P345PR," "P85," "P90," "P91," "P93," "P94," "P95," "P97," "R.I.O.S.," "Ruger Marksman Adjustable," "Ruger 77/50," "Ruger 10/17," "Ruger Titanium," "Security-Six," "Service-Six," "77/357," "Single-Seven," "Speed-Six," "SR45," "SR-556C," "SR-556VT," "SR-762," "Super Bearcat," "Target Grey," "10/22-FS," "This is Ruger. This is America.," "Tri-Flex," "22 Charger," "22/45," and "22/45 RP."

**The Following are Registered U.S. Trademarks Belonging to Sturm, Ruger & Co., Inc.:** "AC-556," "AR-556," "Arms Makers For Responsible Citizens," "All-Weather," "Bearcat," "Blackhawk," "BX-15," "BX-25," Eagle 'R' - soft 'R' & hard 'R', Eagle 'SR', "EC9s," "Everything you need and nothing you don't.," "GP100," "Hawkeye," "It's Mine and It's American," "It's Mine. And It's American," "LC380," "LC9," "LC9s," "LC9s Pro," "LCP," "LCR," "LCRx," "M77," "Mini Thirty," "Mini-14," "9E," "Old Army," "Power Bedding," "Redhawk," "RUGER," "Ruger American Pistol," "Ruger American Pistol" flag design, "Ruger American," "Ruger American Rifle," "Ruger American Rimfire," "Ruger Hunting" - phrase & logo design, "Ruger Inside & Out" - phrase & logo design, "Ruger Precision," "Ruger Precision Rifle," "Ruger 77/17," "Ruger 77/22," "Ruger 77/44," "Ruger SP101," "Ruger 10/22 Takedown" phrase & logo design, "Ruger 22/45 Lite," "Ruger Vaquero," "Rugged, Reliable Firearms," "Security-9," "Silent-SR," "Single-Nine," "Single-Six," "Single-Ten," the "SR" Design, "SR9," "SR9c," "SR40," "SR40c," "SR-22," "SR22," "SR-556," "SR-556 Takedown," "SR1911," "Super Redhawk Alaskan," and "10/22."



# INSTRUCTION MANUAL INSERT FOR

# **RUGER® AR-556®**

## RIFLES CHAMBERED IN .223 WYLDE





Some **RUGER® AR-556®** rifles are chambered in .223 Wylde. These rifles have the same general operational characteristics as all other **RUGER® AR-556®** rifles. Please refer to the enclosed instruction manual for detailed information and important warnings.

## AMMUNITION

**RUGER® AR-556®** rifles chambered in .223 Wylde can be identified by the caliber marking on the muzzle end of the barrel. Note that the .223 Wylde designation refers to a chamber design and not a particular caliber. Firearms chambered in .223 Wylde are designed to function with newly manufactured, factory loaded 5.56 NATO and .223 Remington ammunition manufactured to U.S. and international industry standards.

**USE ONLY FACTORY AMMUNITION LOADED  
TO U.S. INDUSTRY STANDARDS**

|  |  |
|--|--|
|  <h3 style="margin: 0;">WARNING – AMMUNITION</h3> |  |
|   | <p>Use only new, factory ammunition of the correct caliber.</p> <p>Death, serious injury, and damage can result from the wrong ammunition, bore obstructions, powder overloads or incorrect cartridge components.</p> <p><u>Always wear shooting glasses and hearing protection.</u></p> |
|   | <p><b>IMPROPER AMMUNITION<br/>DESTROYS FIREARMS</b></p>  |